

SICS™ MANUAL

SPUHR IDEAL CHASSIS SYSTEM

SPUHR I DALBY AB
Terminalvägen 19, SE-246 42 Löddeköpinge, Sweden



WARNING: Always ensure that the firearm is unloaded – and to adhere to the fundamentals of firearm safety – while installing the firearm into the Spuhr® Ideal Chassis System™.

The Spuhr® Ideal Chassis System™ (SICS™,) Ideal Scope Mount System™ (ISMS™,) and Spuhr Interface® are manufactured by Spuhr i Dalby AB, and the names and likenesses of the Spuhr® brand and products are the sole property of Spuhr i Dalby AB.

Break Free® and CLP® are registered trademarks owned fully by Safariland, LLC.

Loctite® is a registered trademark owned fully by Henkel IP & Holding GmbH.

Tuflok® is a registered trademark owned fully by Nylok LLC.

Spuhr i Dalby AB
Terminalvägen 19
SE-246 42 Löddeköpinge
Sweden

+46-46-712012
info@spuhr.com
www.spuhr.com

v2021

For the latest version of this manual, please visit www.spuhr.com.

Contents

Installation & Initial Setup	3
Adjusting Pistol Grip.....	4
Adjusting Cheek Piece Location	4
A Note About Bedding	5
Operation.....	6
Extending/Folding Stock Assembly	6
Adjusting Length-of-Pull.....	6
Adjusting Butt Plate Height.....	7
Adjusting Cheek Piece Height	8
Presets & Tuning.....	9
Installing Length-of-Pull Presets.....	9
Adjusting Hinge Bolt Tension	12
Adjusting Locking Latch Engagement.....	13
Attaching Accessories	14
Maintenance & Care	15
Forend.....	15
Chassis Body.....	15
LOP Bar.....	16
Butt Plate Assembly	16
Parts List.....	18

Installation & Initial Setup

As with most chassis systems on the market the **Spuhr® Ideal Chassis System™** can be bedded if so desired. The instructions below describe the installation process for an unbedded and/or bedded chassis alike.

1. Remove barreled action from current stock/chassis.
2. Remove bolt from action.
3. Place barreled action into the Spuhr® Ideal Chassis System™.
4. Verify that recoil lug does not bottom out if using custom recoil lug.
5. Insert action screws while applying rearward pressure as to ensure proper recoil lug engagement.

Note: For Remington 700 and clones use 3/16" hex key.
For Tikka T3/T3x use Torx 30 driver.

6. Torque action screws to 45 in/lb (5 Nm).
7. Insert bolt in action and verify that the bolt does not touch the action screws.
 - a. If bolt touches action screws, remove screws, and shorten them as needed.
8. Install forend onto chassis body by sliding it over the barrel.
9. Using a Torx 30 driver, insert the *M6x10 Torx 30 Forend Screws* through forend into chassis body.

Note: If so desired, a small drop of Loctite® 243 Blue can be used on the screws. If so, thoroughly degrease screws prior to install and torque TO 36 in/lb (4 Nm).

10. Starting with the center screw on the bottom of the forend, followed by the center screws on each side, and then the remaining six screws in any order, finger tighten all nine (9) M6x10 screws.
11. Using the process outlined in Step 10 above, torque the screws to 45 in/lb (5 Nm).

Adjusting Pistol Grip

The position of the pistol grip can be adjusted lengthwise for desired trigger engagement,

1. Using a Torx 20 driver, loosen the *Grip Slide Retaining Screw* (orange arrow) located on the right side of the chassis body, above the pistol grip.
2. Using a Torx 20 driver, loosen the *Grip Slide Screw* (green arrow) located behind the tang of the barreled action, on top of the chassis body.
3. Adjust the Pistol Grip position.
4. When satisfied, tighten *Grip Slide Screw*.

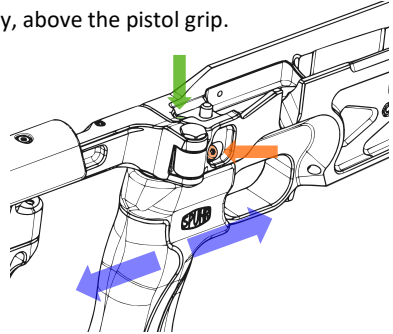

Note: Do NOT use a thread locking agent on the *Grip Slide Screw*.

5. Torque *Grip Slide Retaining Screw* to 17 in/lb.

Note: A small drop of Loctite® 243 Blue can be used on the *Grip Slide Retaining Screw*. If so, thoroughly degrease the screw prior to install and lower torque by 20%.

The SICS™ *Grip Slide* allows the user to replace the SICS™ pistol grip with most AR-pattern pistol grips.

1. Following the instructions for Adjusting Pistol Grip above, move pistol grip to its most rear position and then tighten.
2. Using a 3/16" hex key, unscrew the UC6S 1/4"-28 UNF x 3/4" screw and the serrated lock washer in the bottom of the pistol grip and pull grip down.
3. Install replacement pistol grip using the SICS™ hardware and adjust position as needed.

Note: Pistol grips designed for a high hold, featuring a raised backstrap, may require modification prior to install to ensure that the back strap does not interfere with the movement of the SICS™ folding stock.

Adjusting Cheek Piece Location

The position of the Cheek piece can be adjusted lengthwise for proper scope alignment,

1. Using a Torx 20 driver, unscrew and remove the three (3) Torx 20 screws (green arrows) on top of the *Cheek Piece* (orange).
2. Slide *Cheek Piece* into desired location, align the screw holes in the *Cheek Piece* with the screw holes in the *Cheek Piece Slide*.
3. Insert and tighten two (2) screws until snug.

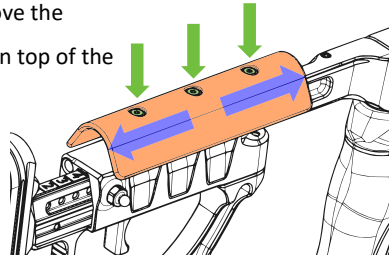

Note: The Torx 20 cheek piece screws are fitted with Tuflok® and should therefore only be tightened until snug.

Tip: Leftover screws can be stored underneath the Cheek Piece, screwed into the stem of the *Cheek Piece Slide*.

A Note About Bedding

As with any stock or chassis system, plastic bedding of the action can often further increase the accuracy and precision of the rifle system.

- Bedding of the SICS™ should be done by a professional gunsmith.
- The bedding should not extend into the cavity surrounding the *Pistol Grip Slide Screw* under the receiver tang.
- Be diligent about applying a release agent to – and plugging – all threaded holes in the sides of the chassis body, as well as the lower part of the two holes in the bottom of the recoil lug recess, and the cavity under the receiver tang, before applying any bedding compound. If using a very liquid bedding compound, additional care may be needed to protect the mag well and the magazine catch.

Operation

Extending/Folding Stock Assembly

1. To extend the folded stock assembly, pull the stock away from the side of the chassis body until it releases.
2. To fold the stock assembly, depress the circular protrusion on the *Stock Locking Latch* and then fold stock fully until it locks onto the side of the chassis body.

Adjusting Length-of-Pull

The stock assembly allows for rapid toolless length-of-pull adjustment with a span of 50 mm (1.97”).

1. To extend the length-of-pull, pinch *LOP Adjustment Lever* (green) and *LOP Adjustment Lever Retaining Plate* (orange) together while pulling on the *LOP Adjustment Lever* to the rear.
 - a. For rapid deployment, pull the *LOP Adjustment Lever* to the rear, forcing the *LOP Bar* with *Butt Pad Assembly* to extend.
2. To shorten the length-of-pull, pinch *LOP Adjustment Lever* and *LOP Adjustment Lever Retaining Plate* together while pushing forward on the *LOP Adjustment Lever Retaining Plate* (orange).

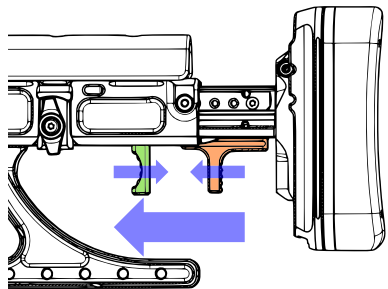
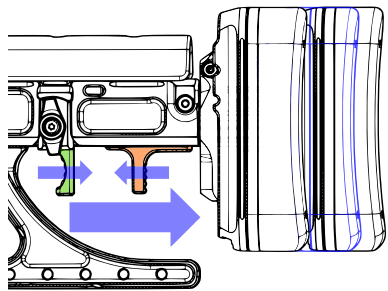

Adjusting Butt Plate Height

The stock assembly allows for rapid toolless adjustment of the Butt Plate height. The adjustment span is 30 mm (1.18”).

1. Push *Butt Plate Locking Button* (green arrow) on left side of *Butt Plate Assembly*.
2. Slide *Butt Plate Assembly* (orange) into desired position while holding *Butt Plate Locking Button* depressed.

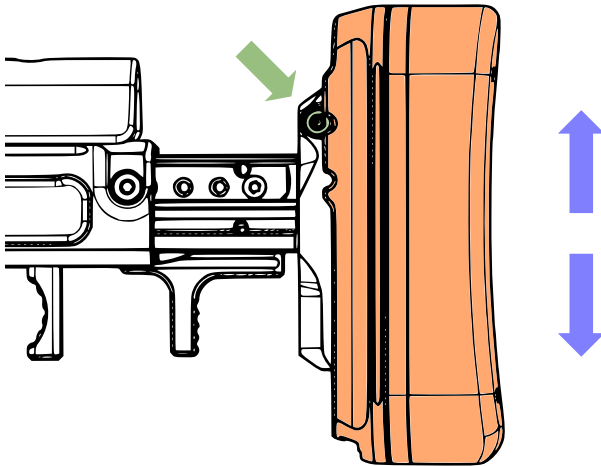

Adjusting Cheek Piece Height

1. To raise or lower the *Cheek Piece Slide*,
 - a. Loosen the *Cheek Piece Slide* (orange) by rotating the *Cheek Piece Wing Nut* (green) on left side of the *Folding Stock Frame Assembly* counter-clockwise.

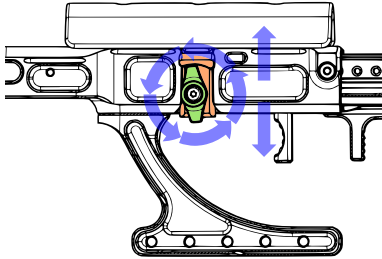

- b. Slide cheek piece assembly up or down.
- c. To secure *Cheek Piece Slide*, rotate the *Cheek Piece Wing Nut* clockwise.

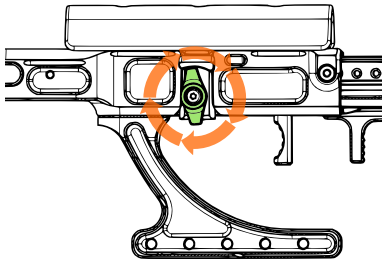

2. The rotation of the *Cheek Piece Wing Nut* can be adjusted by pulling on the wing nut outwards, rotating it to the desired position, and then releasing it.

Presets & Tuning

Installing Length-of-Pull Presets

If desired, length-of-pull presets can be installed using a Torx 20 driver and two A-0132 M4x10 screws (a 10-pack is provided).

Note: The SICS™ comes with a LOP preset installed from the factory (red below) to prevent over-extension and damage to the LOP Bar. Removing this screw will void the warranty.

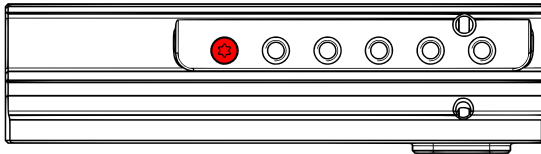

1. To set the minimum length-of-pull
 - a. Extend the stock assembly one step past the required minimum position.
 - b. Using a Torx 20 driver, insert an A-0132 M4x10 screw (green) into the threaded hole on the left side of the LOP Bar nearest to the Folding Stock Frame:

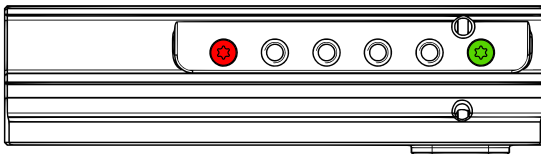

Figure 1: Preset (green) installed for *min extension* at the #1-position.

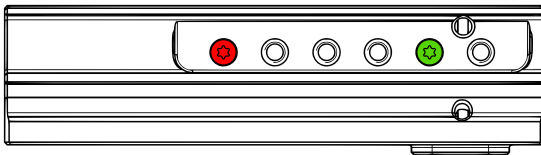
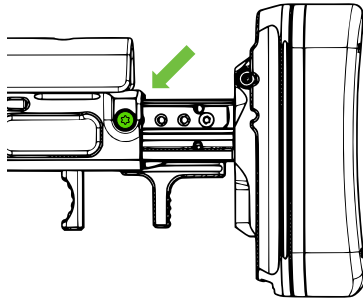

Figure 2: Preset (green) installed for *min extension* at the #2-position.

2. To set the maximum length-of-pull

- a. Extend the stock assembly to the desired maximum length. Make note of the number engraved into the top of the *LOP Bar* closest to the *Folding Stock Frame* (right).
- b. Using a Torx 20 driver, loosen the M5x10 Torx 20 retaining screw (green) on the rear left side of the *Folding Stock Frame*.



- c. Pinch the *LOP Adjustment Lever* and *LOP Adjustment Lever Retaining Plate* together while pulling *LOP Adjustment Lever* to the rear to separate the *LOP Bar* from the *Folding Stock Frame*.
- d. Slowly let go of the *LOP Adjustment Lever* and *LOP Adjustment Lever Retaining Plate*.

Note: The *LOP Adjustment Lever* is under spring pressure and the lever and spring may eject if released too quickly.

- e. Using a Torx 20 driver insert an A-0132 M4x10 screw (green) into the threaded hole on the left side of the LOP Bar one step UP from the engraved number noted in step 2.a:

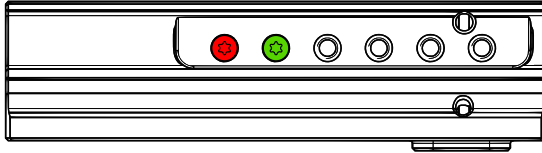

Figure 3: Preset (green) installed for **max extension** at the #5-position.

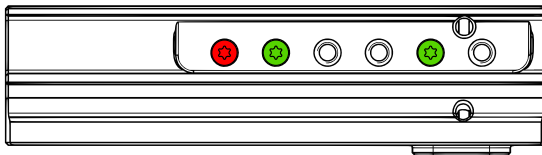

Figure 4: Presets (green) installed for **max** at #5-pos and **min** at #2-pos.

- f. To assemble the stock assembly, repeat steps 2.b to 2.d in the opposite order but make sure that the LOP Bar is only inserted so far that the preset screw for the minimum extension is still visible.
- i. If no minimum LOP preset is installed, insert LOP Bar fully before reinstalling the M5x10 Torx 20 retaining screw in step 2.b.

Tip: The A-0132 M4x10 screw is also used to attach the top covers on the **Spuhr® Ideal Scope Mount System™ (ISMS™)**. Two spare screws can be stored underneath the Cheek Piece, screwed into the stem of the *Cheek Piece Slide*.

Adjusting Hinge Bolt Tension

If needed the tension of the *Hinge Bolt* (green) can be adjusted as to make the “swing” of the buttstock assembly tighter or looser.

Tip: Prior to making any adjustment, apply masking tape to chassis body or to the tool, to prevent marring of the finish where the spanner will ride.

1. To tighten hinge bolt tension, using a ½” spanner, rotate *Hinge Bolt* clockwise (orange) until desired tension is achieved.
2. To loosen hinge bolt tension, using a ½” spanner, rotate *Hinge Bolt* counter-clockwise until desired tension is achieved.

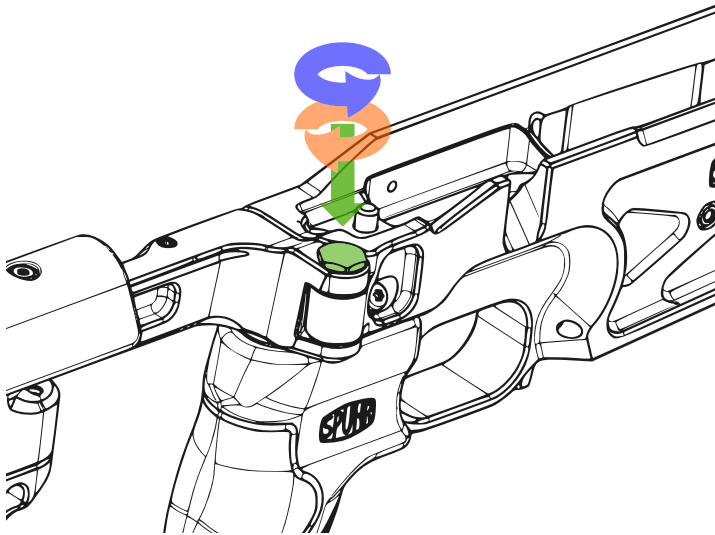

Adjusting Locking Latch Engagement

If needed the engagement of the *Locking Latch* can be adjusted by moving the *Adjustable Locking Plate*.

Note: This adjustment should only be needed after extensive use, or if lockup begins to feel sloppy.

1. With the stock assembly folded, using a Torx 20 driver, loosen the three Torx 20 *Locking Plate Screws* (green) securing the *Adjustable Locking Plate* (orange) two turns counterclockwise.

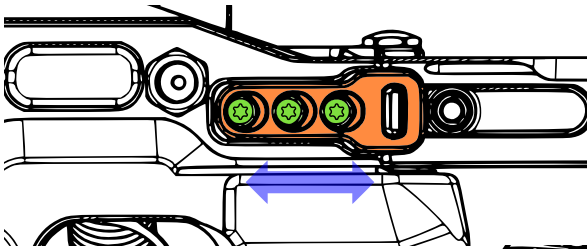

2. Using a Torx 20 driver, adjust the position of the *Adjustable Locking Plate* by tightening (clockwise) or loosening (counterclockwise) the *Locking Plate Adjustment Screw* (blue) as needed.

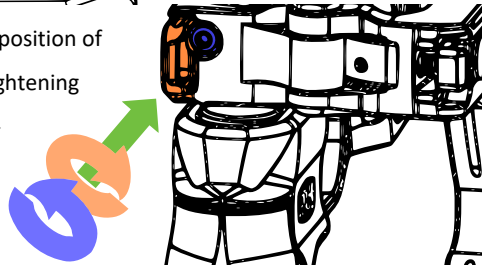

3. Once satisfied, tighten all three Torx 20 *Locking Plate Screws*.
4. Test locking latch engagement.
 - a. If further adjustment is needed, repeat 1-4.
 - b. When satisfied, torque the three *Locking Plate Screws* to 25 in/lb.

Attaching Accessories

The **Spuhr® Ideal Chassis System™ (SICS™)** is a highly modular system, which shares the same proprietary interface system as the **Spuhr® Ideal Scope Mount System™ (ISMS™)** – the **Spuhr Interface®**, consisting of circular grooves and ridges surrounding M4 screw holes – which allows accessories developed for the ISMS™ line of scope mounts and upgrade kits to be used on the SICS™ and vice versa.

To attach an ISMS™ accessory,

1. Make sure that the interface surface on the chassis is dry and clean from debris.
2. Press the back of the accessory against Spuhr Interface® at the desired location.
3. Insert the M4 Torx 20 screws included with the accessory and, with a Torx 20 driver, tighten screws.

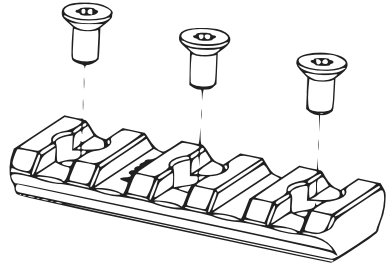

Note: If so desired, a small drop of Loctite® 243 Blue can be used on each screw. If so, thoroughly degrease the screws prior to install. Do NOT use Loctite® on the interface surfaces.

If attaching SICS™ accessory to an ISMS™ scope mount, gauge the screw length prior to install as to prevent over-penetration resulting in damage to the scope tube.

Maintenance & Care

Forend

- To ensure the proper function of the *Spuhr Interfaces™* along the forend, use a rag, brush, or compressed air to remove any dirt or debris from the circular grooves and from the M4-threaded holes of the interfaces prior to attaching any accessories.
- To ensure the proper function of the two *QD Sling Cups* on top of the forend, use a rag or a cotton swab to remove any dirt or debris from the axial grooves on the inside of the cups and then apply a light coat of Break Free® CLP® or similar gun oil to the cups' exterior and interior.

Chassis Body

- To ensure proper lockup of the *Stock Locking Stud* into the *Stock Locking Cup* when buttstock assembly is folded, use a brush or compressed air to remove any dirt or debris hiding behind the *Locking Cup Spring*.

Note: Be careful not to bend the *Locking Cup Spring* by using any type of hard tool to reach behind the spring.

- To ensure proper operation of the *Magazine Catch*, use compressed air or a cotton swab to remove any dirt or debris behind the mag catch.
- To lubricate the *Magazine Catch*, apply a drop of Break Free® CLP® or similar gun oil in the gap between the side of the *Magazine Catch* and the *Chassis Body*. Work the *Magazine Catch* several times to spread the lubricant.
- Depending on frequency of use, occasionally verify that two *Action Screws*, the *Torx 20 Grip Slide Retaining Screw*, and the three *Torx 20 Locking Plate Screws* are properly torqued.

- If the Folding Stock Assembly is starting to move too easily, see the section about Adjusting Hinge Bolt Tension under **Presets & Tuning**.

LOP Bar

- To ensure smooth operation of the *LOP bar*, extend the stock fully and use a rag, to wipe off any dirt or debris, then apply a thin coat of Break Free® CLP® or similar gun oil along the top, sides, and bottom of the *LOP Bar*.
 - If needed, remove the *LOP Bar* in accordance with step 2 b under **Presets & Tuning** for a thorough cleaning of the *LOP Bar channel* in the *Folding Stock Frame*.
- To lubricate the *LOP Adjustment Lever*, hold stock upside down, pinch the *LOP Adjustment Lever* and *LOP Adjustment Lever Retaining Plate* together and then apply a drop of Break Free® CLP® or similar gun oil in the rounded groove in front of the *LOP Adjustment Lever*. Work the *LOP Adjustment Lever* several times to ensure that the lubricant spreads along the axle.
 - If needed, remove the *LOP Bar* in accordance with step 2 b under **Presets & Tuning** and then remove the *LOP Adjustment Lever* with spring for a thorough cleaning of the *LOP Adjustment Lever* and the *LOP Adjustment Lever channel* in the *LOP Bar*.

Butt Plate Assembly

- To ensure smooth operation of the *Butt Plate Assembly*, use a rag to wipe off any dirt or debris from the exposed parts of the assembly, then slide the *Butt Plate* to its highest position. Use a rag, brush, or a cotton swab to clean the inside tracks of the *Butt Plate*, then apply a thin coat of Break Free® CLP® or similar gun oil along the inside tracks of the *Butt Plate*.
Move the *Butt Plate* to its lowest position. Use a rag, brush, or a cotton swab to clean the inside tracks of the *Butt Plate*, then work the *Butt Plate Assembly* up and down twice to spread the lubricant in the tracks.

- To ensure smooth operation of the *Butt Plate Locking Button*, use a brush or pressurized air to remove any dirt or debris between the *Butt Plate Locking Button* and the *Butt Plate Base*.
- To lubricate the *Butt Plate Locking Button*, apply a drop of Break Free® CLP® or similar gun oil in the gap between the *Butt Plate Locking Button* and the *Butt Plate Base*. Work the button several times to spread the lubricant.
 - If needed, compressed air can be used to blow into the hole in the button to remove any debris or dirt.

Parts List

No.	Function, SKU, and Description	Qty
1.	<i>Picatinny Rail Interface</i> A-0002 8x55 mm Picatinny Rail (Includes 4 pcs of A-0124 M4x8 Torx 20 screws)	1
2.	<i>Forend Screws</i> P-130 M6x10 Tx30 Forend Screws 10-pack	9
3.	<i>Locking Plate Screws, Locking Plate Adjustment Screw, Grip Slide Retaining Screw, and Recoil Pad Screws</i> A-0183 M4x12 Screw Tx20 MRT 8.8 ISO14583 P2T	7
4.	<i>Locking Plate Screw washers and Grip Slide Retaining Screw washers</i> S-1803 BRB 4,3x8x0,8 ISO4759-3 P2T 200HV	4
5.	<i>Magazine Catch Screw and Locking Latch Screw</i> S-1358 Screw M4x27 Tx15 Corr-I-Dur	2
6.	<i>Magazine Catch Spring</i> S-2003 Compression Spring Dt-0.7 Dm-3.93, L0-14 Stainless	1
7.	<i>Grip Slide Screw</i> A-0130 M5x25 Screw Tx20 MRT 10.9 ISO 14583 P2T+G627	1
8.	<i>Grip Slide Screw Washer</i> A-0180 Washer BRB 5,3X10X1 ISO 7089 P3T	1
9.	<i>Grip Slide Lock Nut</i> S-2020 M5 Square Nut DIN557 TufLok®A2K	1
10.	<i>Cheek Piece Screws</i> A-0178 M4x8 Tx20 MRT 8.8 ISO 14583 P2T+Tuflok	3
11.	<i>LOP Retaining Screw and Butt Plate Retaining Screw</i> S-1354 M5x10 Tx20 Retaining Screw	2
12.	<i>LOP Preset Screws, LOP Adjustment Lever and Retaining Plate Screws</i> A-0132 M4x10 Screw Tx20 MFT 10.9 7955 P2T, or P-120 M4x10 Screw Tx20 MFT 10.9 7955 P2T, 10-pack	5